





Luminarias polivalentes
Recessed luminaires

Luminarias polivalentes empotrables
Multipurpose recessed luminaires



SERIE 400

Luminarias empotrables polivalentes para modulaciones de perfil visto o techos de escayola. La pantalla está fabricada en acero termo esmaltado en blanco.

El sistema de sujeción al techo puede realizarse mediante el uso de garras metálicas (opcionales, Ref. GR), realizadas en acero galvanizado.

SERIE 400

Multipurpose recessed luminaires for all types of ceilings, T-bar or plaster ceilings.

The luminaire is made of termoemalted steel in white colour.

The luminaires can be joined to the plaster ceilings using optional bracketts (option, Ref. GR) made in steel.



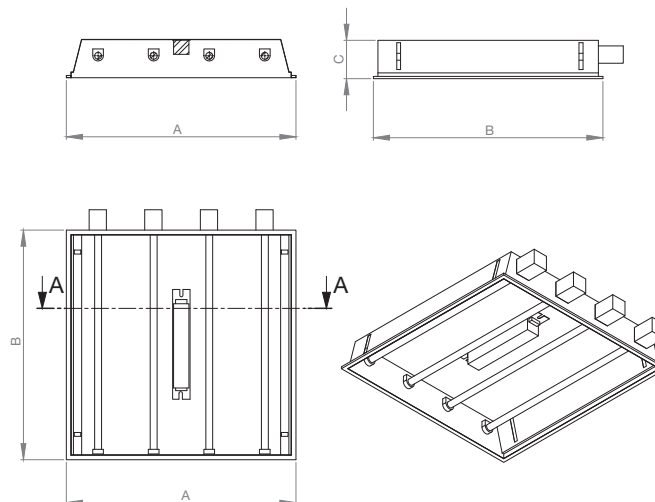
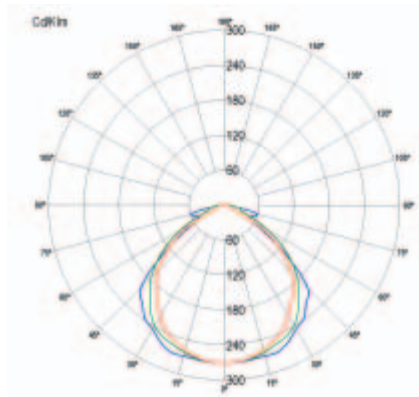

Luminarias polivalentes empotrables
Multipurpose recessed luminaires

Ref.	T8	T5	PL	A	B	C		IP	HFR	HF	KIT EMERGENCIA
400	2x18W	2x28/54		295	595	92	275x575	20/43*	SI/YES	SI/YES	SI/YES
	2x36W			295	1195	92	275x1175	20/43*	SI/YES	SI/YES	SI/YES
	2x58W			295	1495	92	275x1475	20/43*	SI/YES	SI/YES	SI/YES
	3x18W	4x14/24		595	595	92	575x575	20/43*	SI/YES	SI/YES	SI/YES
	3x36W			595	1195	92	575x1175	20/43*	SI/YES	SI/YES	SI/YES
	3x58W			595	1495	92	575x1475	20/43*	SI/YES	SI/YES	SI/YES
	4x18W			595	595	92	575x575	20/43*	SI/YES	SI/YES	SI/YES
	4x36W			595	1195	92	575x1175	20/43*	SI/YES	SI/YES	SI/YES

*Con difusor opal
 *With opal diffuser



Luminarias polivalentes empotrables
Multipurpose recessed luminaires

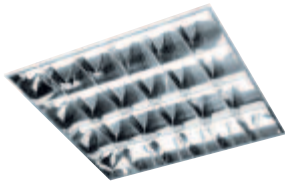

Dif. 370
Brillo / *Shine*
Doble parabólico / *Double parabolic*

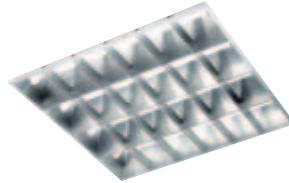

Dif. 375
Mate / *Matt*
Doble parabólico / *Double parabolic*

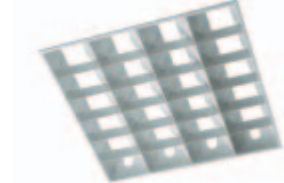

Dif. 180
Blanco / *White*
Doble parabólico / *Double parabolic*



Dif. 060
Opal / *Opal*
Metacrilato opal | prisma
Opal | *prismatic diffusor*

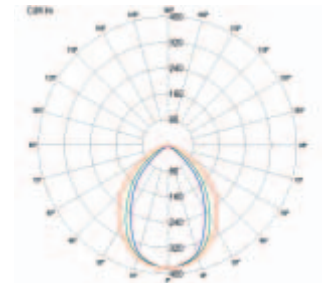
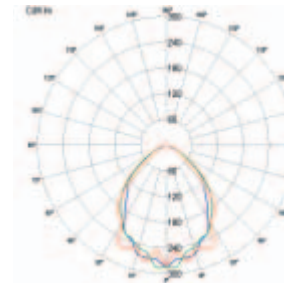
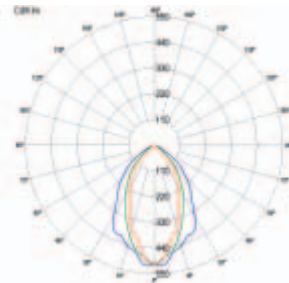
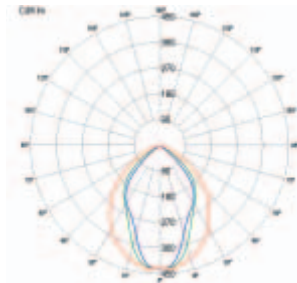

Difusor doble parabólico brillo realizado integralmente en aluminio especular de alta pureza. Disponible en aluminio nacional (Ref.370) o aluminio de importación anodizado (Ref. 380). Puede ir abierto en cabeceras (Ref. SC) o cerrado (Ref. CC)

Double parabolic shine aluminium louver. High quality aluminium available in non anodized finished (Ref.370) or anodized (Ref. 380). It can be produced with open tops (Ref. SC) or close tops (Ref. CC).

Difusor doble parabólico mate realizado integralmente en aluminio de alta pureza. Disponible en aluminio nacional (Ref.375) o aluminio de importación anodizado (Ref. 385). Puede ir abierto en cabeceras (Ref. SC) o cerrado (Ref. CC)

Double parabolic matte aluminium louver. High quality aluminium available in non anodized finished (Ref.375) or anodized (Ref. 385). It can be produced with open tops (Ref. SC) or close tops (Ref. CC).

Difusor doble parabólico blanco realizado integralmente en aluminio precalado blanco (Ref. 180).

Double parabolic white aluminium louver, produced with high quality aluminium (Ref.180).

Difusor realizado en metacrilato opal (Ref. 060) de 3mm de espesor, colocado sobre un marco de chapa. El marco se sujeta a la pantalla mediante muelles. Puede ser sustituido por difusor prisma (Ref. 050).

Opal plastic 3mm diffusor(Ref. 060), inserted in the steel frame joined to the luminaire by special designed springs. Can be also produced whitth prismatic diffusor (Ref. 050)

Luminarias polivalentes empotrables
Multipurpose recessed luminaires

Accesorios de conexión / Conexión accesories

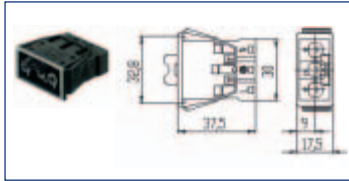

Ref.: 18i3

Conector hembra empotrable de 3 polos disponible.

Female 3-poles connector available.

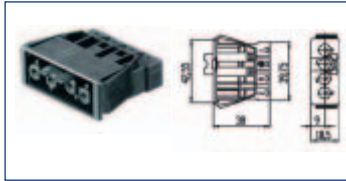

Ref.: 18i4

Conector hembra empotrable de 4 polos disponible.

Female 4-poles connector available.

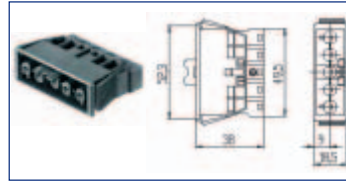

Ref.: 18i5

Conector hembra empotrable de 5 polos disponible. Especialmente indicado para regulación.

Female 5-poles connector available. Special designed to use with dimable systems.



Ref.: Schuko

Conector Schuko aéreo con manguera de 1, 2 y 3 metros.

1, 2 or 3 meters cable with Schuko connector available.



Garras de sujeción para techos especiales disponibles bajo pedido.
Brackets for special roofs available under order(request).



1
 Extracción del difusor.
Louver remove.

Montaje e instalación / Installation

Instalación y equipamiento de la luminaria.
Drawing of luminaire intalation.

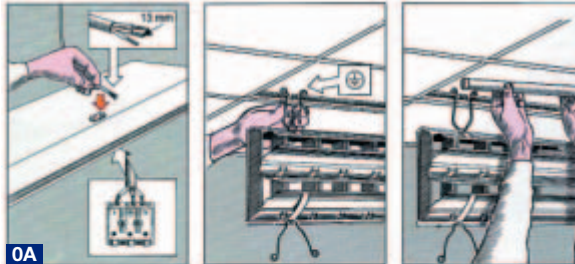

0A

Conector interior de serie.
Inside connector included.

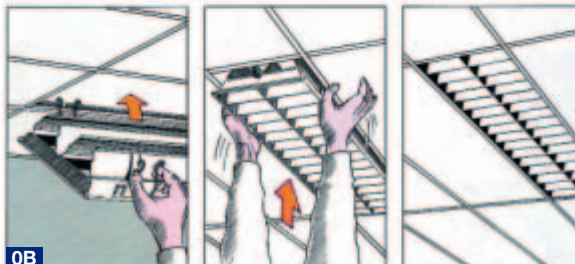

0B

Muelles especiales de sujeción.
Special joint springs for louver.

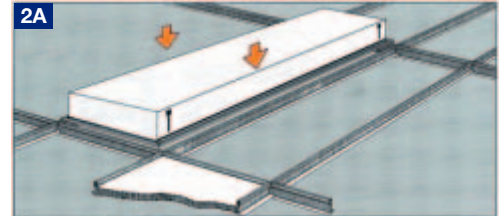

2A Instalación en techo perfil visto.
Luminaire installed in a T-bar ceiling.

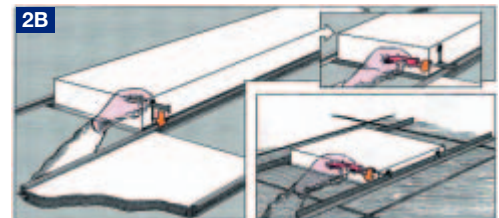

2B Instalación mediante uso de garras.
Luminaire instaled using brackets.

Luminaria empotrable para lampara compacta
Multipurpose recessed luminaire for compact lamps

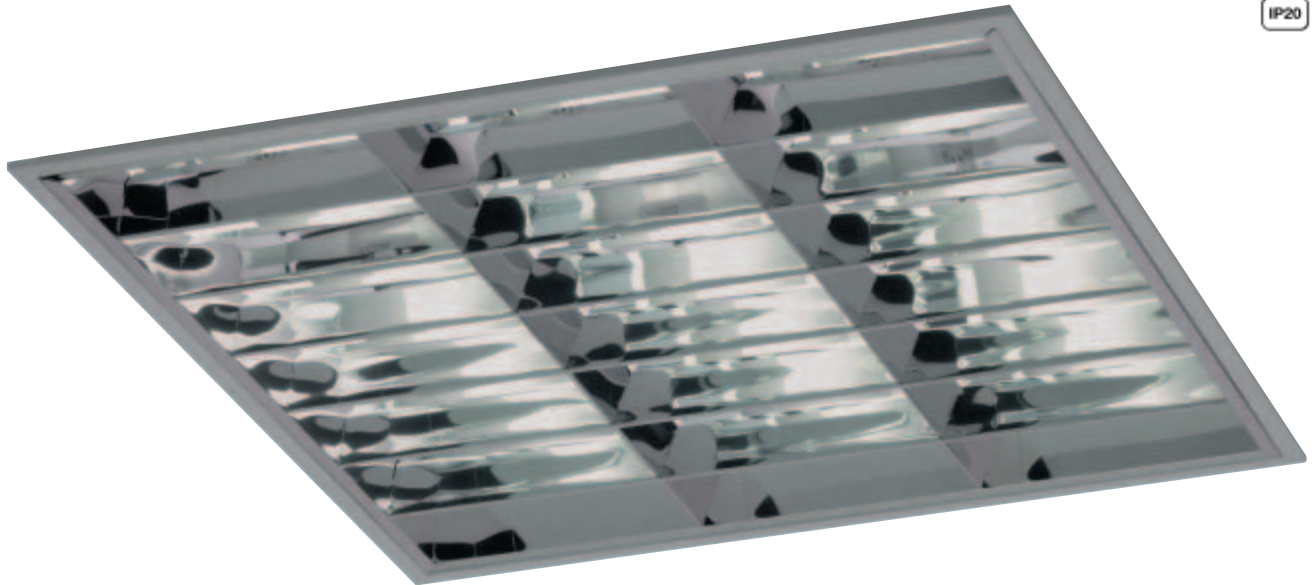

SERIE 401

Luminarias empotrables polivalentes para lámparas compactas. La pantalla está realizada en de acero termo esmaltado blanco.

La luminaria puede ser instalada en techos de escayola con la ayuda de garras opcionales (Ref. GR) fabricadas en acero galvanizado.

SERIE 401

Multipurpose recessed luminaires for compact lamps.

The luminaire's body is made in white termoemaltered steel.

To install the luminaire in plaster ceilings, optional brackets (Ref. GR) can be used.



Luminaria empotrable para lampara compacta
Multipurpose recessed luminaire for compact lamps

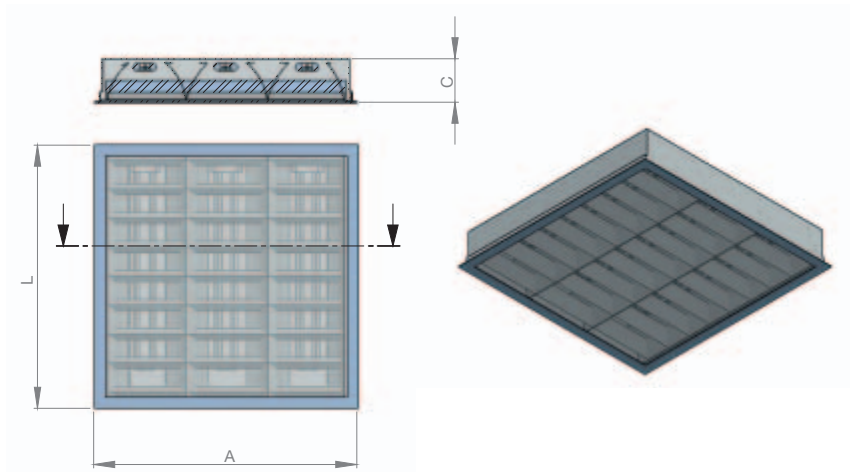
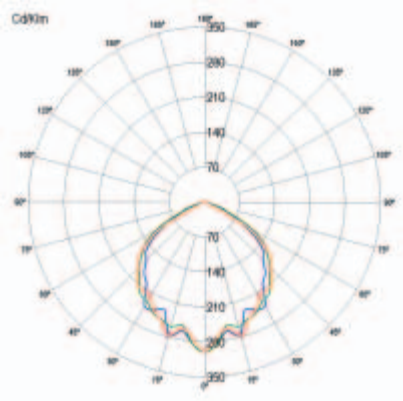

Ref.	T8	T5	PL	A	L	C		IP	HFR	HF	KIT EMERGENCIA
401			2x36W	595	595	92	550x550	20	SI/YES	SI/YES	SI/YES
			2x40W	595	595	92	550x550	20	SI/YES	SI/YES	SI/YES
			2x55W	595	595	92	550x550	20	SI/YES	SI/YES	SI/YES
			3x36W	595	595	92	550x550	20	SI/YES	SI/YES	SI/YES
			3x40W	595	595	92	550x550	20	SI/YES	SI/YES	SI/YES
			3x55W	595	595	92	550x550	20	SI/YES	SI/YES	SI/YES



Ref.: garras

Garras de sujeción para techos especiales disponibles bajo pedido.
Brackets for special roots available under order(request).



Luminaria empotrable de marco ancho
Wide frame recessed luminaire



SERIE 402

Luminarias empotrables polivalentes de marco ancho para lámparas compactas. La pantalla está fabricada en acero termo esmaltado blanco.

SERIE 402

Wide frame multipurpose recessed luminaires for compact lamps, T-bar or plaster ceilings. The luminaire is made of white termoemalted steel.

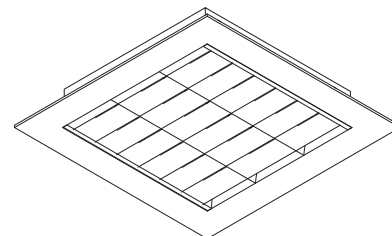
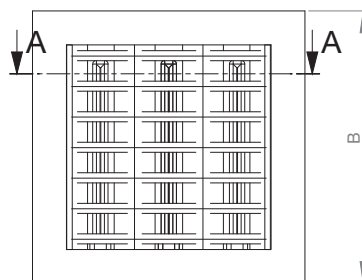
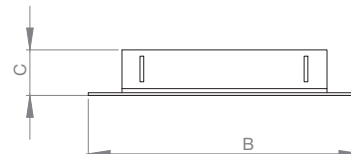
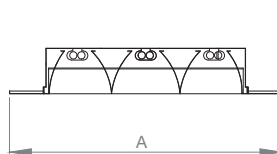
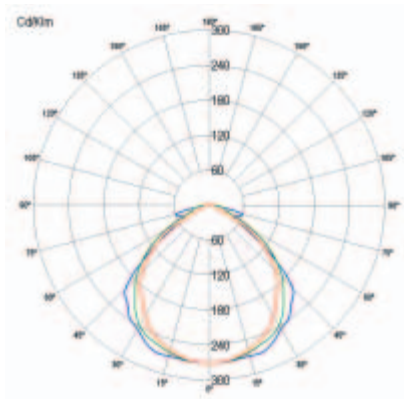

Luminaria empotrable de marco ancho
Wide frame recessed luminaire

Ref.	T8	T5	PL	A	B	C		IP	HFR	HF	KIT EMERGENCIA
402			2x18W	595	595	92	575x575	20	SI/YES	SI/YES	SI/YES
			2x24W	595	595	92	575x575	20	SI/YES	SI/YES	SI/YES
			2x36W	595	595	92	575x575	20	SI/YES	SI/YES	SI/YES
			3x18W	595	595	92	575x575	20	SI/YES	SI/YES	SI/YES
			3x24W	595	595	92	575x575	20	SI/YES	SI/YES	SI/YES
			3x36W	595	595	92	575x575	20	SI/YES	SI/YES	SI/YES

Ref.: garras

Garras de sujeción para techos especiales disponibles bajo pedido.
 Brackets for special roots available under order(request).



Luminarias polivalentes empotrables de marco ancho
Multipurpose recessed luminaires

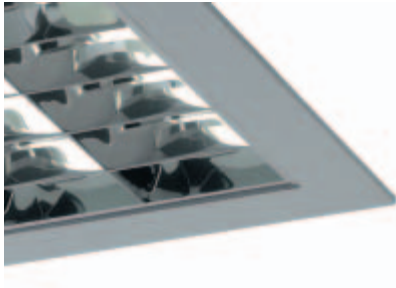

Dif. 370
Brillo / *Shine*
Doble parabólico / *Double parabolic*

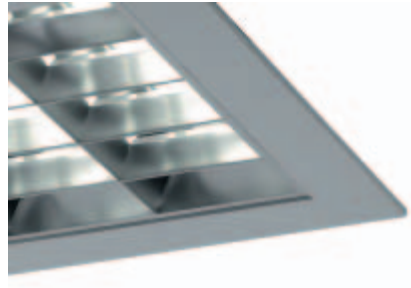

Dif. 375
Mate / *Matt*
Doble parabólico / *Double parabolic*

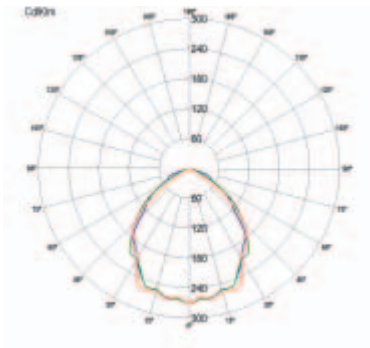

Difusor doble parabólico brillo realizado integralmente en aluminio especular de alta pureza. Disponible en aluminio nacional (Ref.370) o aluminio de importación anodizado (Ref. 380). Puede ir abierto en cabeceras (Ref. SC) o cerrado (Ref. CC)

Double parabolic shine aluminium louver. High quality aluminium available in non anodized finished (Ref.370) or anodized (Ref. 380). It can be produced with open tops (Ref. SC) or close tops (Ref. CC).

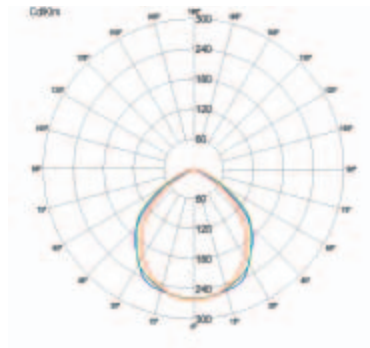

Difusor doble parabólico mate realizado integralmente en aluminio especular de alta pureza. Disponible en aluminio nacional (Ref.375) o aluminio de importación anodizado (Ref. 385). Puede ir abierto en cabeceras (Ref. SC) o cerrado (Ref. CC)

Double parabolic matte aluminium louver. High quality aluminium available in non anodized finished (Ref.375) or anodized (Ref. 385). It can be produced with open tops (Ref. SC) or close tops (Ref. CC).



Luminaria empotrable con difusor de baja luminancia
Low luminance recessed luminaire



SERIE 407

Luminarias empotrables polivalentes compuesta de óptica parabólica laminar de lama alta. Este sistema combina un elevado rendimiento con un alto confort visual.

SERIE 407

Multipurpose recessed luminaires that presents a high blade laminar parabolic louver. This system combines high performance with excellent visual confort.



Luminaria empotrable con difusor de baja luminancia
Low luminance recessed luminaire

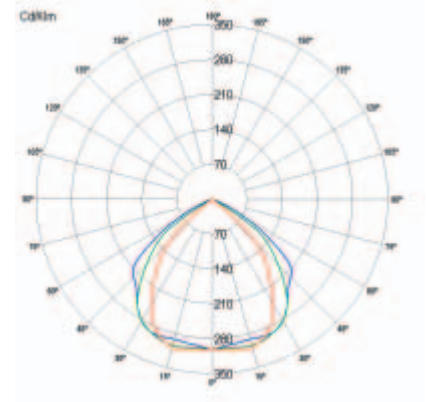
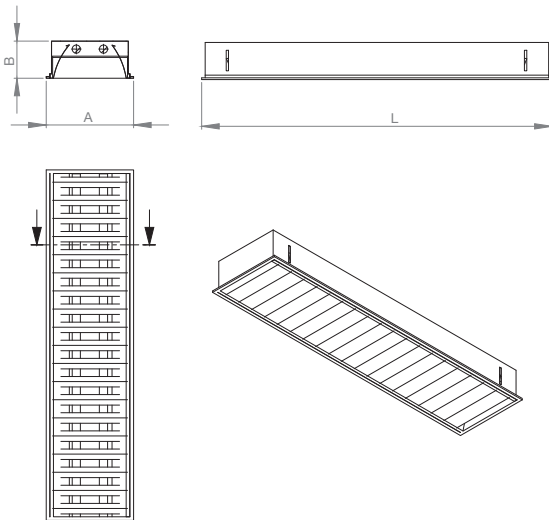

Ref.	T8	T5	PL	A	L	B		IP	HFR	HF	KIT EMERGENCIA
407	1x18W	1x14/24		295	595	127	275x575	20	SI/YES	SI/YES	SI/YES
	1x36W	1x28/54		295	1195	127	275x1175	20	SI/YES	SI/YES	SI/YES
	1x58W	1x35/49		295	1495	127	275x1475	20	SI/YES	SI/YES	SI/YES
	2x18W	2x14/24		295	595	127	275x575	20	SI/YES	SI/YES	SI/YES
	2x36W	2x28/54		295	1195	127	275x1175	20	SI/YES	SI/YES	SI/YES
	2x58W	2x34/49		295	1495	127	275x1475	20	SI/YES	SI/YES	SI/YES

Ref.: garras

Garras de sujeción para techos especiales disponibles bajo pedido.
Brackets for special roofs available under order(request).





Luminaria empotrable en línea continua
Continuous row recessed luminaire



SERIE 404

Luminarias empotrables polivalentes de línea continua para modulaciones de perfil visto o techos de escayola. Permite la instalación como luminaria individual (de serie) o como para montaje línea continua (opcional). Puede suministrarse con diferentes anchos, desde 150 mm (Ref. 405), 200 mm (Ref. 404) o 300 mm (Ref. 403).

Se puede fabricar con difusor aluminio brillo (Ref. 370L), mate (Ref. 375L) o blanco (Ref. 180L).

SERIE 404

Multipurpose recessed luminaires for continuous row mounting. It can be delivered for individual mounting (Standard) or continuous row mounting (Optional). It can be made in 150 mm (Ref. 405), 200 mm (Ref. 404) or 300 mm (Ref. 403).

It can be produced with shine aluminium louver (Ref. 370L), matt aluminium louver (Ref. 375L) or white (Ref. 180L).





Luminaria empotrable en línea continua Continuus row recessed luminare



Ref. 405

Ancho 150 mm / Width 150 mm
Empotramiento 125 mm / Ceiling hole 125 mm

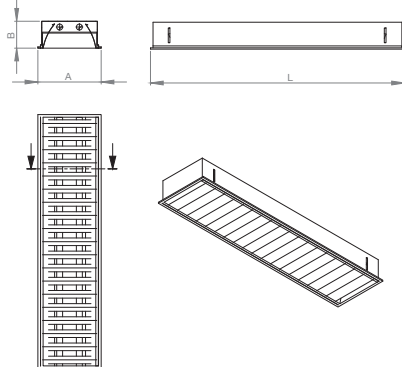

Ref. 405

Luminarias empotrables polivalentes de línea continua para modulaciones de perfil visto o techos de escayola. Permite la instalación como luminaria individual (de serie) o como para montaje línea continua (opcional). Se puede fabricar con difusor aluminio brillo (Ref. 370L), mate (Ref. 375L) o blanco (Ref. 180L). El ancho de la luminaria es 150 (exterior) con un hueco de techo de 120 mm. Las luminarias que van colocadas en la cabeza de la línea continua están cerradas por un lateral, mientras que las intermedias (Ref. INT) están fabricadas para ser ensambladas por la parte anterior y posterior.

Multipurpose recessed luminaires for continuous row mounting. It can be delivered for individual mounting (Standard) or continuous row mounting (Optional). It can be produced with shine aluminium louver (Ref. 370L), matt aluminium louver (Ref. 375L) or white (Ref. 180L).



Ref. 404

Ancho 200 mm / Width 200 mm
Empotramiento 175 mm / Ceiling hole 175 mm

Ref.	T8	T5	PL	C	L	B		IP
405	1x18w	1x14/24		145	618	92	125xLN	20
	1x36w	1x28/54		145	1225	92	125xLN	20
	1x58w	1x35/49		145	1525	92	125xLN	20
404	1x18w	1x14/24		195	618	92	175xLN	20
	1x36w	1x28/54		195	1225	92	175xLN	20
	1x58w	1x35/49		195	1525	92	175xLN	20
	2x18w	2x14/24		195	618	92	175xLN	20
	2x36w	2x28/54		195	1225	92	175xLN	20
403	2x58w	2x35/49		195	1525	92	175xLN	20
	2x18w	2x14/24		295	618	92	275xLN	20
	2x36w	2x28/54		295	1225	92	275xLN	20
	2x58w	2x35/49		295	1525	92	275xLN	20

LN: longitud resultante de la suma de las longitudes de cada una de las luminarias que conforman la línea continua.

Ref. 404

Luminarias empotrables polivalentes de línea continua para modulaciones de perfil visto o techos de escayola. Permite la instalación como luminaria individual (de serie) o como para montaje línea continua (opcional). Se puede fabricar con difusor aluminio brillo (Ref. 370L), mate (Ref. 375L) o blanco (Ref. 180L). El ancho de la luminaria es 200 (exterior) con un hueco de techo de 175 mm. Las luminarias que van colocadas en la cabeza de la línea continua están cerradas por un lateral, mientras que las intermedias (Ref. INT) están fabricadas para ser ensambladas por la parte anterior y posterior.

Multipurpose recessed luminaires for continuous row mounting. It can be delivered for individual mounting (Standard) or continuous row mounting (Optional). It can be produced with shine aluminium louver (Ref. 370L), matt aluminium louver (Ref. 375L) or white (Ref. 180L).



Ref. 403

Ancho 300 mm / Width 300 mm
Empotramiento 275 mm / Ceiling hole 275 mm

Ref. 403

Luminarias empotrables polivalentes de línea continua para modulaciones de perfil visto o techos de escayola. Permite la instalación como luminaria individual (de serie) o como para montaje línea continua (opcional). Se puede fabricar con difusor aluminio brillo (Ref. 370L), mate (Ref. 375L) o blanco (Ref. 180L). El ancho de la luminaria es 300 (exterior) con un hueco de techo de 275 mm. Las luminarias que van colocadas en la cabeza de la línea continua están cerradas por un lateral, mientras que las intermedias (Ref. INT) están fabricadas para ser ensambladas por la parte anterior y posterior.

Multipurpose recessed luminaires for continuous row mounting. It can be delivered for individual mounting (Standard) or continuous row mounting (Optional). It can be produced with shine aluminium louver (Ref. 370L), matt aluminium louver (Ref. 375L) or white (Ref. 180L).





Luminaria empotrable en línea continua
Continuus row recessed luminare

Accesorios de conexión / *Conexion accesories*

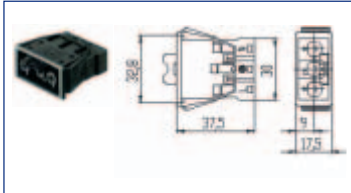

Ref.: 18i3

Conector hembra empotrable de 3 polos disponible.
Female 3-poles connector available.

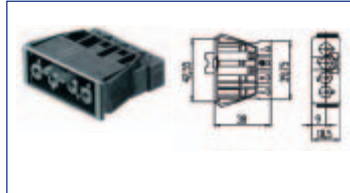

Ref.: 18i4

Conector hembra empotrable de 4 polos disponible.
Female 4-poles connector available.

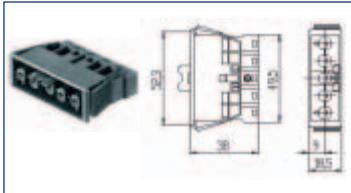

Ref.: 18i5

Conector hembra empotrable de 5 polos disponible. Especialmente indicado para regulación.
Female 5-poles connector available. Special designed to use with dimable systems.



Ref.: Schuko

Conector Schuko aéreo con manguera de 1, 2 y 3 metros.
1, 2 or 3 meters cable with Schuko connector available.



Clema de sujeción de serie para tres polos.
Standar three poles Connector in all the luminaires.



Garras de sujeción para techos especiales disponibles bajo pedido.
Brackets for special roofs available under order(request).

Sistema de montaje individual / *Instalation instructions*



A
 Conector interno de serie.
Inside connector installed.

B
 Bandeja porta equipos de fácil desmontaje.
Control gear pannel with easy instalation system.

C
 Muelles especiales para sujeción del difusor.
Easy springs for louer instalation.

D
 No colocar nada sobre la luminaria.
Do not locate luminaries under cables or air-condition tubes.

Luminaria de superficie bajo perfil
Surface mounted luminaire



SERIE 420

Luminarias de superficie para tubo T8. Cuerpo fabricado en chapa de acero termoestablado, está disponible en dos colores, blanco y acero brillante. Con capacidad de ser equipada con 1 o 2 tubos destaca por su reducida altura y aspecto estético.

Especialmente diseñada para montaje en suspensión.

Sistemas de suspensión disponibles de forma opcional.

SERIE 420

Surface luminaires for T8 lamps. The body is made in thermo enamelled steel. The louvers are specially designed to obtain a high performance. Special designed for suspended mounting. Suspension systems available as option.



Luminaria de superficie bajo perfil
Surface mounted luminaire

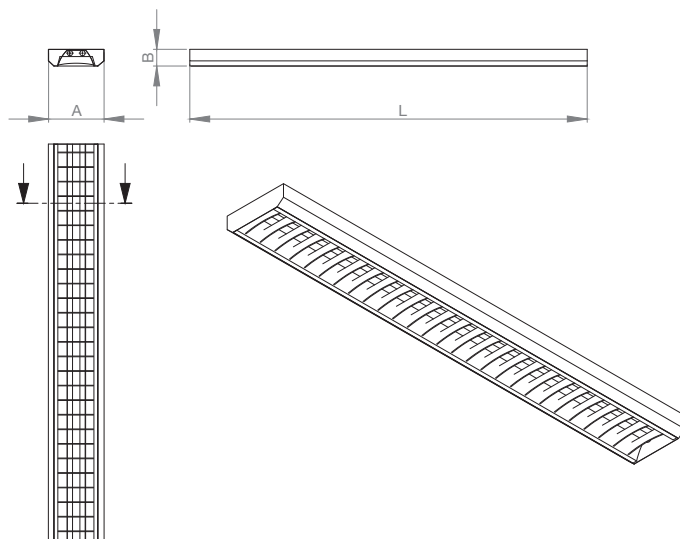
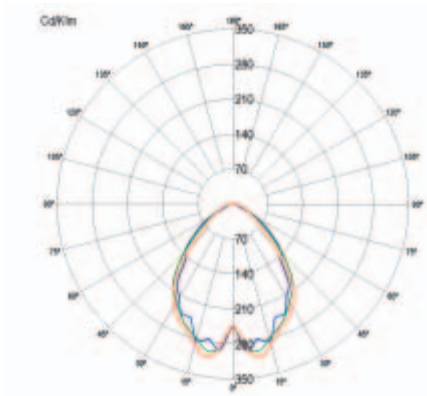

Ref.	T8	T5	PL	A	L	B	IP	HFR	HF	KIT EMERGENCIA
420	1/2x18W			168	635	48	20	SI/YES	SI/YES	SI/YES
	1/2x36W			168	1235	48	20	SI/YES	SI/YES	SI/YES
	1/2x58W			168	1535	48	20	SI/YES	SI/YES	SI/YES



Luminaria de superficie bajo perfil
Surface mounted luminaire

Sistema de montaje / Installation instructions

1

Extracción del difusor.
Louver remove.

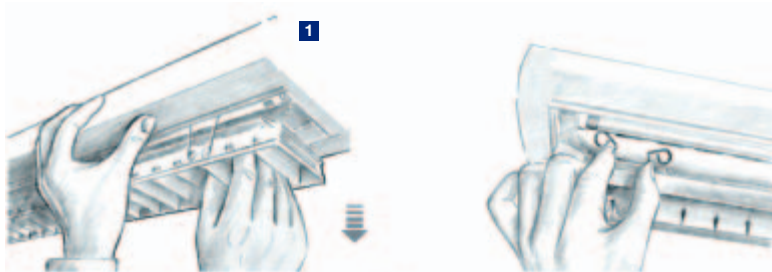

2

Conectores empotrados de 3, 4 y 5 polos disponibles.
3, 4 and 5 poles recessed connectors available.



A

Tapas laterales realizadas en ABS de sencilla instalación.
Plastic end caps included.



B

Sistemas especiales de unión para línea continua.
Special joint parts for continuous rows.



Ref.: Schuko

Conector Schuko aéreo con manguera de 1, 2 y 3 metros.
1, 2 or 3 meters cable with Schuko connector available.

Ref.: Suspensión kit

